

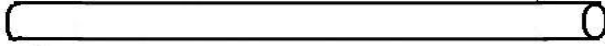

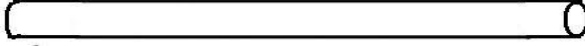

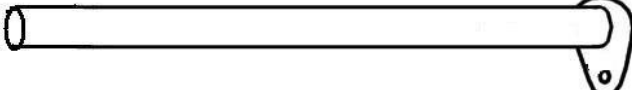

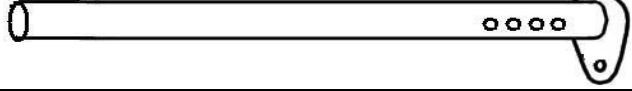

INSTRUCTIONS

Part no.	3X6M PE	Quantity
1 Frame pole		8
2 Frame pole		9
3 Support pole		4
4 Support pole		4
A connector		6
B connector		6
Guy line		4
Spiral peg		4
Long peg		8
Short peg		31
Bungee balls		74
Finger Screw		42
Hook		4
Roof		1
Sidewall		2
Endwall		2

INSTRUCTIONS

I Select a flat ground for the tent, unpack the carton and check all the parts including tubes, tent and accessories... etc. are present as same as list. Assemble the framework of rooftop by joining the portion (A,B) together with poles (1.2). To ensure the screw fixed to every pole tightly .

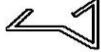
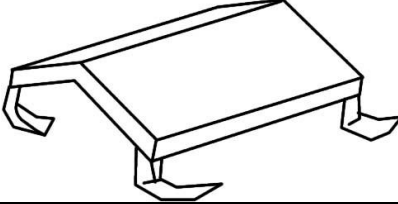
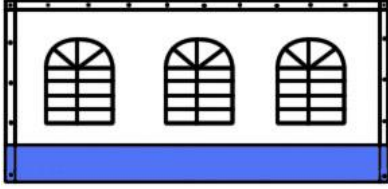
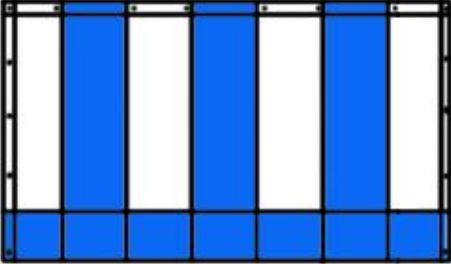
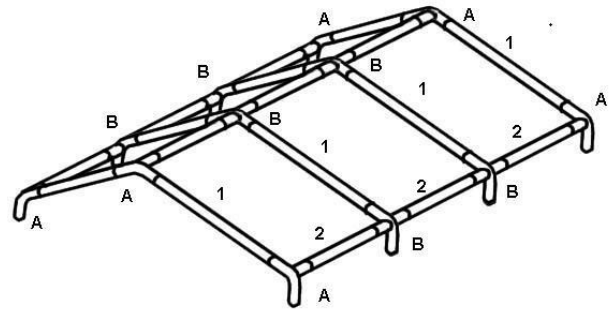

II Attach one end of supported pole (3) to the joints (A,B)

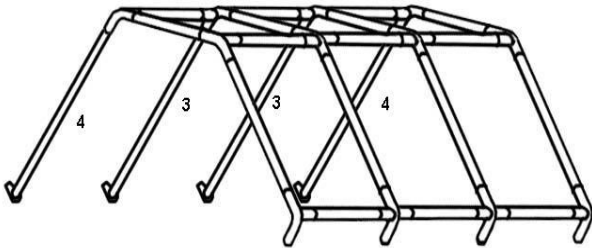

III Cover the roof on the frame ,and attach it by the bungee balls properly ,take care of the tension of the bungee balls ,for if you use too many on one side of tent ,it may too tight to tie the other side of it .

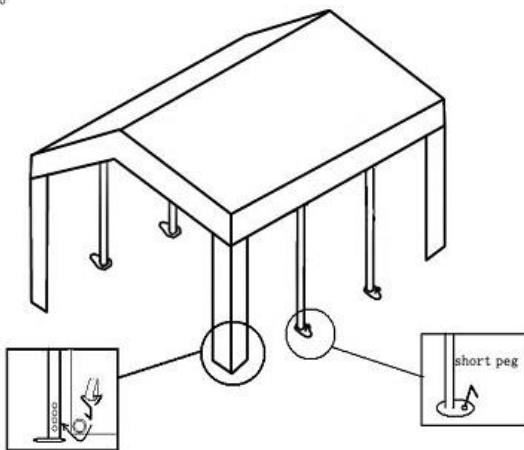
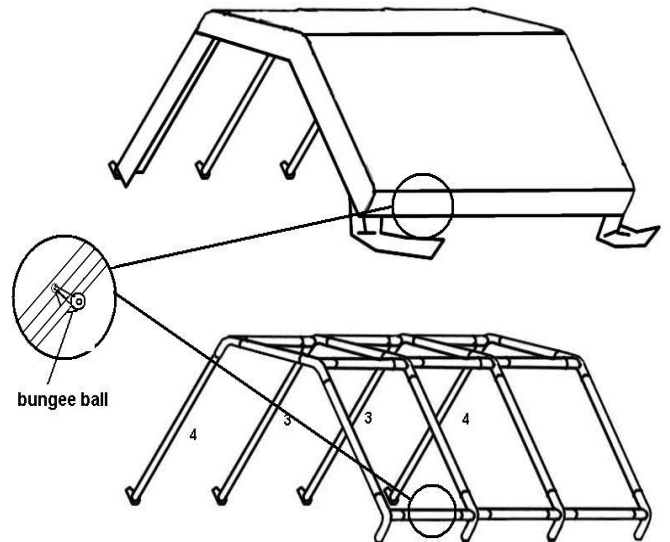

sidewall to ground.

IV Attach the another 4 supported poles (3,4) to the joints (A,B), built-up the framework ,use the long peg to fix each pole into the ground and use the hook to fix the leg cover to the leg . Four spiral peg and the rope is used to tie the four corner of the tent, to tie it to the ground, each leg with one long peg, small peg is used to fix the skirt of

INSTRUCTIONS

V spread the wall panel and door panel attach to framework by using the bungee cords clasping the frame to grommets that is construct over the wall panel and door panel to ensure stability. Also use the short pegs to fix the skirt to the ground .

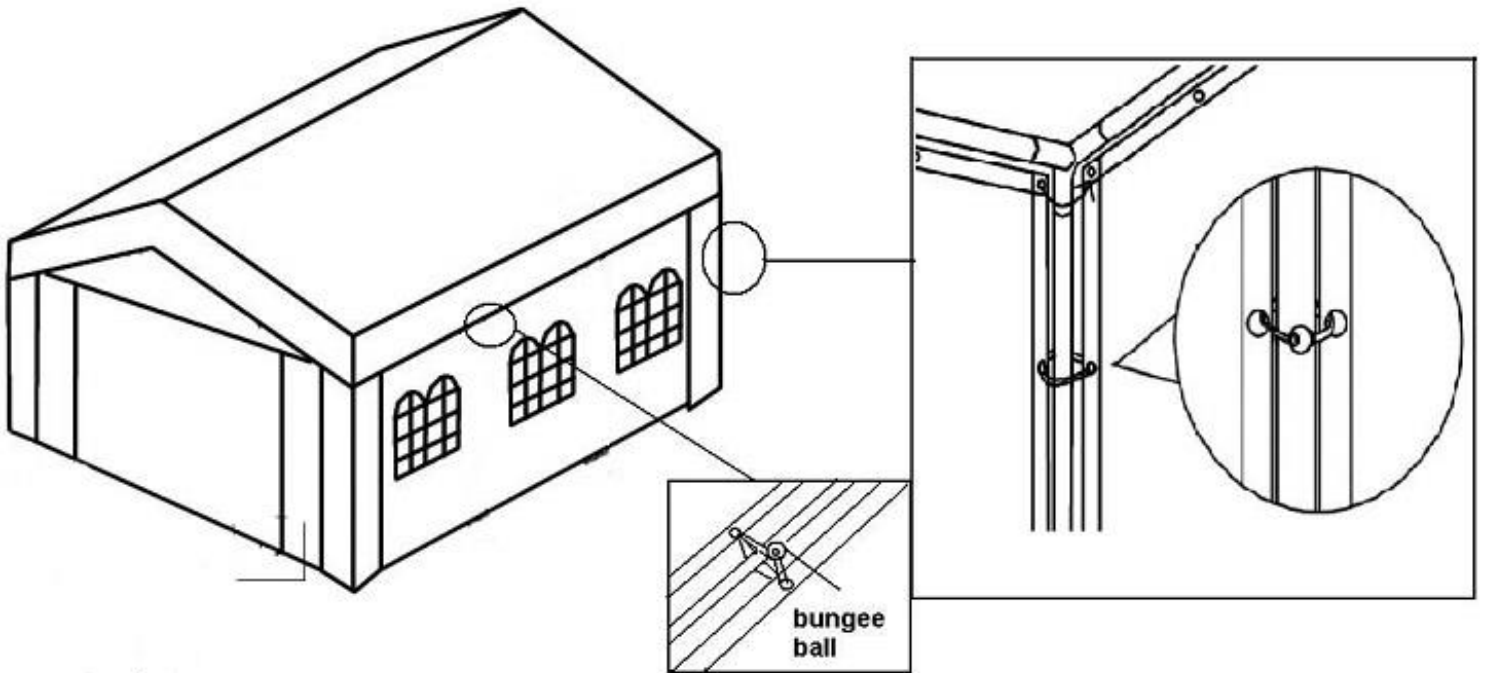

VI The Guy lines clasp to each corner of tent and another end of line fix to ground by spiral pegs

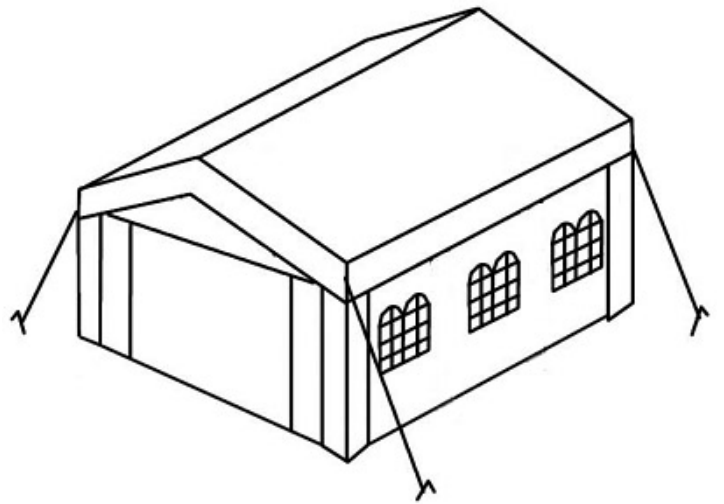

Warning

1. Take note that the tent needs to be handled carefully to avoid damage.
2. Do not force the frame as they may be damage in the process.
3. Tents are meant as temporary shelter and must be evacuated under extreme weather conditions.
4. Please select a suitable site for the tent to avoid the damage to underground sprinkler systems, water, gas or electrical lines.